



TUMBLE DRYER, 7 KG

Model: TD6-7

Article no: 9871830089

Power supply: 480V 3Ph ~60Hz

The TD6-7 tumble dryer is featuring exceptional savings and easy use. The display can easily be moved to the bottom of the tumble dryer for a better position when stacked. Certified ergonomic design with a human-centred approach for outstanding user experience. A horizontal filter drawer for easy access and cleaning without the need to bend down when stacked on a WH6-6. Innovative features to save money and time, and embrace a sustainable lifestyle. Monitor the equipment and performance from anywhere, allowing to take action and to improve the business with OnE Laundry - the personal assistant for hygiene validation management, process management and revenue management.

The dryer offers outstanding productivity - dry more laundry in less time.

The reversing drum minimises wrinkles and drying time, the result is an effective and even drying performance.

Some variants have insulated glass door (see variants) which keeps the door cool on the outside and heat on the inside, so the room temperature is not affected.

MAIN FEATURES

- Reversible door hanging
- Reversing drum
- Horizontal filter drawer
- Flexible position of the display
- Certified ergonomic design

TD6-7, 9871830089

16-01-24 (13:47)

Subject to change without notice
For correct installation, refer to the installation manual

Model Number Specific	TD6-7
Voltage (V)	480
Phase	3
Frequency (Hz)	60
Loading (kW)	6,3
Fuse (A)	10
IP Class	X4
Capacity (kg)	7
Capacity, filling factor	1:18
Capacity, filling factor (kg)	7,5
Width, net (mm)	600
Depth, net (mm)	845
Height, net (mm)	1050
Weight, net (kg)	97
Weight, gross (kg)	109
Volume, net (m3)	0,53
Volume, gross (m3)	0,69
Connection Cable, length (m)	0
Plug type	None
Certifications	CE, Ergocert (Ergonomics Certified)
Door Hanging	Left (is reversible)
Drum type	Galvanized
Dryer, type	Vented
Drying cycle time (min)	30
Energy consumption (kW/h)	3,04
Exterior	Colored
Installation, type	Floor model
Noise level <(dB)	63
Other general information	Exhaust outlet Ø125, Heating Power 6 kW
Residual moisture control	Yes
Reversing drum	Yes
SS Front panel	No
Stackable	Yes
Touch control	No

Volume, drum (L)	135
-------------------------	-----

Loipart AB (HQ), **Sweden**
Tel. +46 313 920 100, loipart@loipart.se

LMG Finland oy, **Finland**
+358 40 664 6680, lmg@lmg.fi



Loipart USA inc. **USA**
Tel. +1 954 530 5276, loipartusa@loipart.com

Loipart SEA Pte Ltd, **Singapore**
Tel. +65 674 99 100, contact@loipart.sg

Visit us at www.loipart.com

DIMENSIONS

Model: TD6-7 Rev. 2

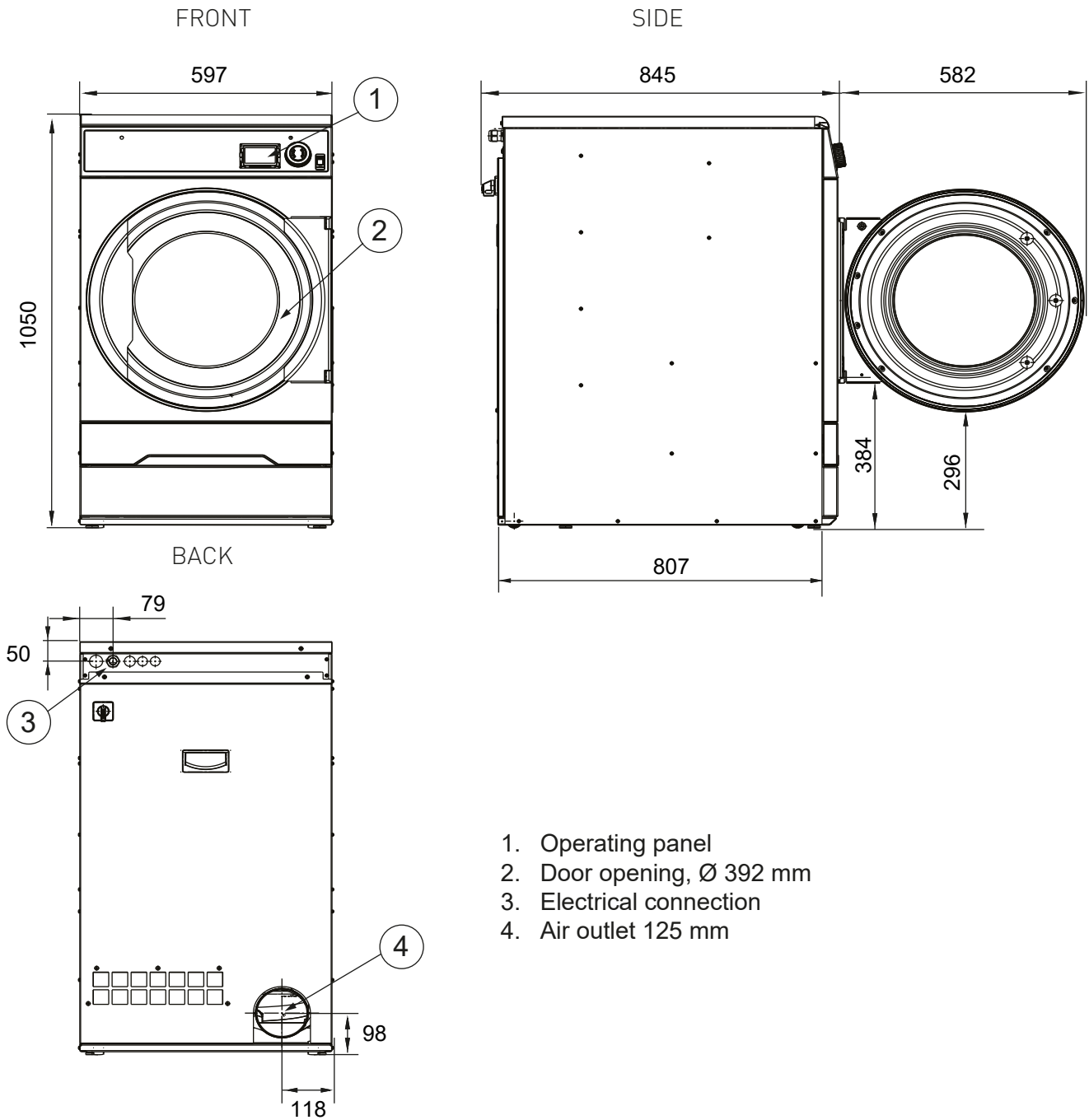

POSITIONING OF MACHINE

The machine should be positioned so that there is plenty of room for working, both for the user and service personnel. The figure shows minimum distance to a wall and/or other machines.

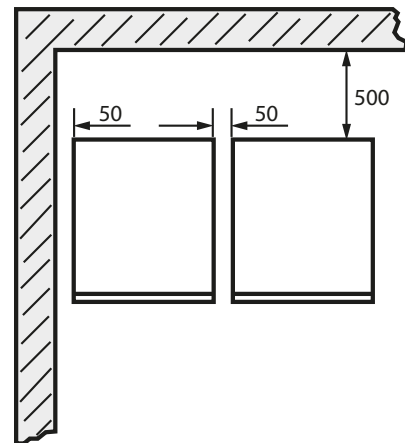

DIMENSIONS

Model: TD6-7 Rev. 1

MARINE INSTALLATION

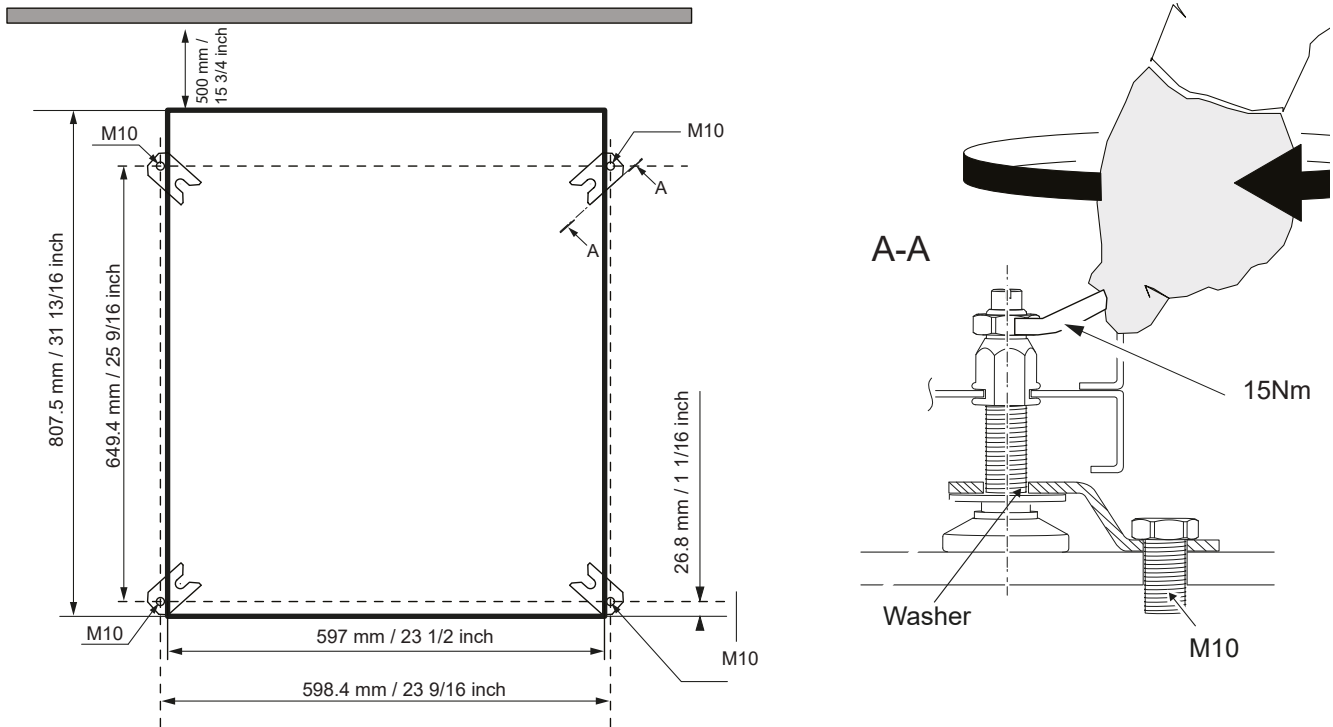

To ensure steadiness of the machine it is important to fasten the machine to the foundation.

Fasten the four fittings (supplied with the marine machine model) to the foundation using four x M10 set screws.

Fasten the machine to the fittings.



It is recommended that each machine is connected to a separate exhaust duct.

Air principles

Note! It is very important that the machine gets enough fresh air in order to get the best drying result.

The fan creates low pressure in the machine, drawing air into the drum via the heating unit. The heated air passes through the garments and the drum holes and flows out through the filter positioned below the drum. The air is then evacuated through the fan and exhaust system.

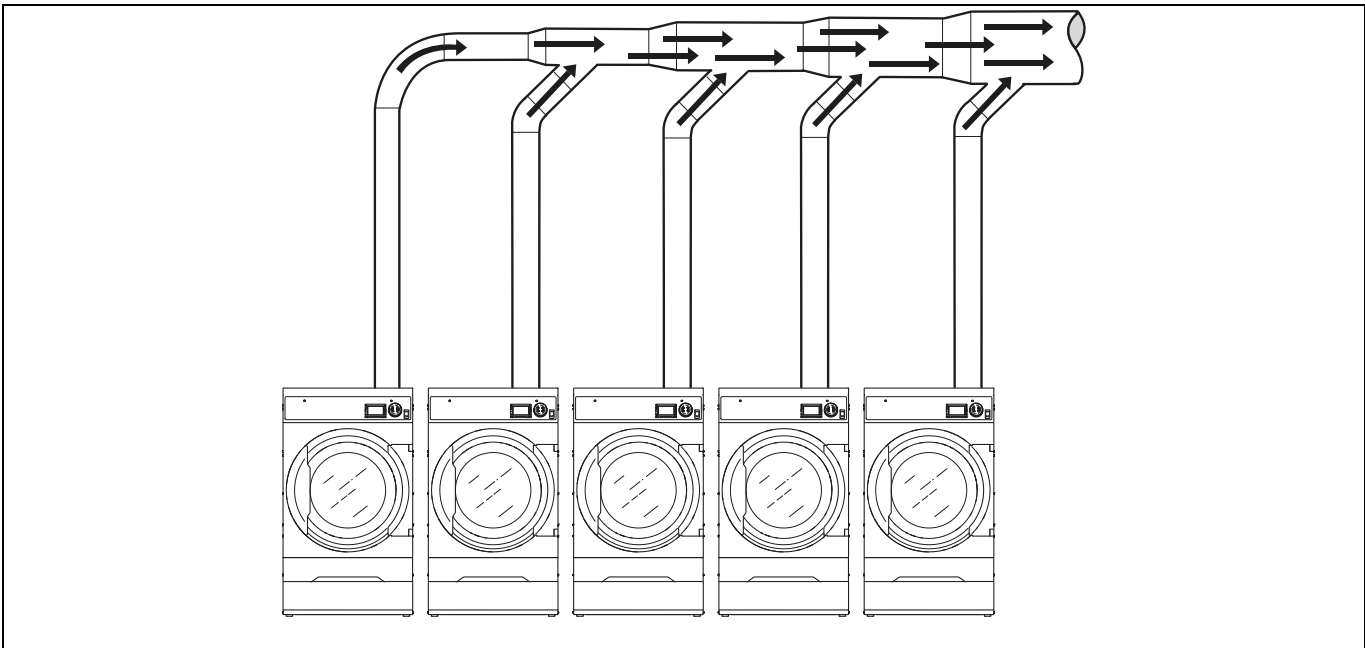

Number of machines		1	2	3	4	5	6	7	8	9	10
Exhaust duct	∅ mm	100	160	200	200	250	250	315	315	315	315
Recommended area of fresh air intake	m ²	0.04	0.1	0.16	0.16	0.25	0.25	0.39	0.39	0.39	0.39
Minimum area of fresh air intake	m ²	0.011	0.022	0.033	0.044	0.055	0.066	0.077	0.088	0.099	0.11



The exhaust duct diameter must not be reduced.

Exhaust dimensioning

Note! The exhaust duct diameter must not be reduced.

It is important that the machine has correct air volume compared to each machines power.

If the air flow is smaller or larger this will result in a longer drying period.

If the outlet pipe is long or the ventilation is not properly designed we recommend to clean the outlet pipes periodically. Usually, longer ducts need more frequent cleaning.

The exhaust pipes shall be short in order for the machine to work in the best way.

All cover panels must be mounted in order for the machine to work in the best way.