



PLANETARY MIXER 20L WITH HUB

Model: LMX20

Article no: JT205H230601

Power supply: 230V 1Ph ~60Hz

This planetary mixer has a cast iron body and a powerful custom built motor with three fixed speeds. It's belt driven with gear box and high torque transmission. Heat-treated hardened steel alloy gears and shafts and permanently lubricated transmission. The mixer is operated in front and has a 15 minute interval timer and a thermal overload protection. The mixer is equipped with a stainless steel bowl guard and lift. It also has a built in ingredient chute for adding ingredients while the mixer is running.

With the attachment hub (#12) it's possible to make the mixer with the attachments (optional extras) as meat mincer and vegetable preparation.

MAIN FEATURES

- Three fixed speeds and timer.
- Overload protection.
- Bowl detection device.
- Ingredient chute.
- Attachment hub #12.
- Supplied with spiral hook, paddle and whisk.

LMX20, JT205H230601
15-01-24 (16:10)

TECHNICAL DATA

LMX20, JT205H230601, 15-01-24 (16:10)

Model Number Specific	LMX20
Voltage (V)	230
Phase	1
Frequency (Hz)	60
Loading (kW)	0,6
Capacity (L)	20
Capacity (kg)	6,8
Width, net (mm)	552
Depth, net (mm)	544
Height, net (mm)	921
Weight, net (kg)	95
Weight, gross (kg)	140
Volume, net (m3)	0,45
Volume, gross (m3)	0,58
Connection Cable, length (m)	1,8
Plug type	None
Attachment drive	Yes
Installation, type	Table top model
Mixer, type	Planetary
Noise level <(dB)	65,5

INCLUDED IN DELIVERY

A 20 liter stainless steel bowl, flat beater (aluminum), stainless steel wire whip & spiral dough hook (aluminum)

Loipart AB (HQ), **Sweden**
Tel. +46 313 920 100, loipart@loipart.se

LMG Finland oy, **Finland**
+358 40 664 6680, lmg@lmg.fi



Loipart USA inc, **USA**
Tel. +1 954 530 5276, loipartusa@loipart.com

Loipart SEA Pte Ltd, **Singapore**
Tel. +65 674 99 100, contact@loipart.sg

Visit us at www.loipart.com

DIMENSIONS

Model: LMX20 Rev. 1

FRONT

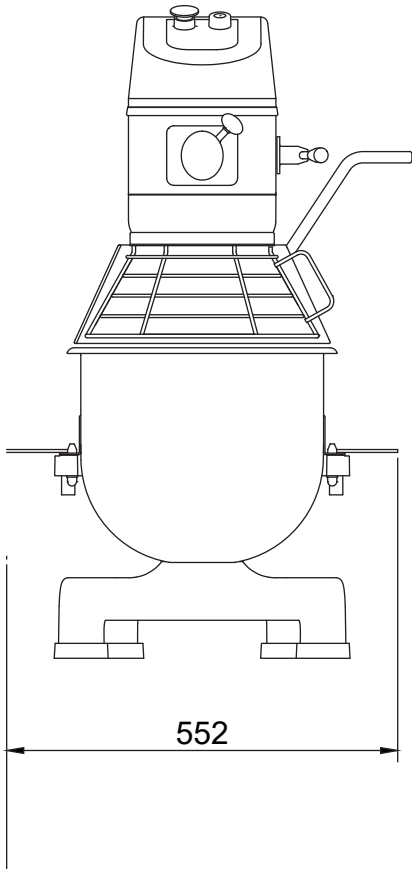

SIDE

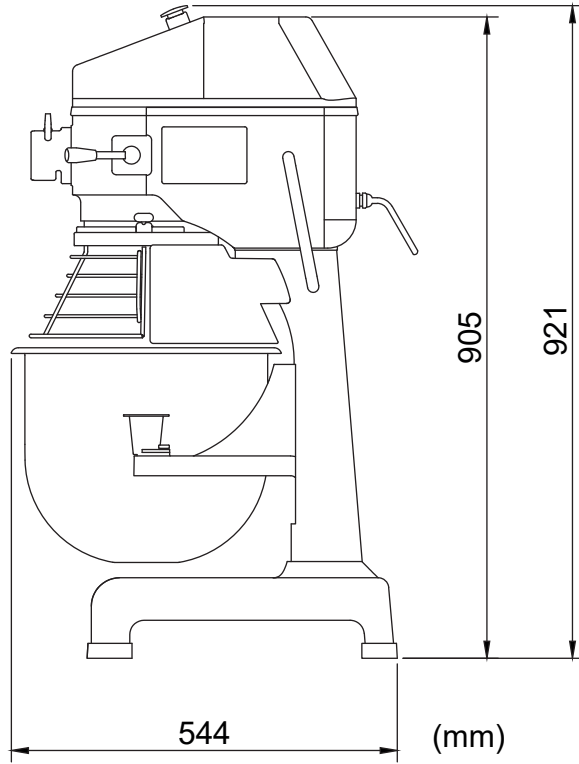

DETAIL MARINE FEET

