



COMBI OVEN ICOMBI PRO 6 GN 1/1

Model: iCombi Pro 61

Article no: L20045

Power supply: 230V 3Ph ~50/60Hz

With the iCombi intuitive operating concept, everyone can work error-free from the start. The idea runs through the production process with visual imagery, logical work steps, and clear, interactive instructions.

iDensityControl is the intelligent climate management system in the iCombi Pro. Thanks to the interaction of sensors, high-performance heating system and live steam generator, and active dehumidification, a correct cooking chamber climate is always available. The intelligent air turbulence ensures the best possible energy input into the food to obtain exceptional productivity and quality.

The iCookingSuite is the cooking intelligence in the iCombi Pro. Initially, the user selects the cooking path from 7 operating modes and 4 cooking methods to suit the food. Then specifies the desired cooking result. The unit suggests possible adjustment, and the intelligent sensors recognize the food's size, quantity, and condition. Depending on the cooking progress, all-important cooking parameters such as temperature, cooking chamber climate, airspeed, and cooking time are adjusted to the second.

The iProductionManager organizes the production process intelligently and flexibly. This includes which products can be cooked together on different inserts, the optimal order of foods, and the cooking process's monitoring. The iProductionManager supports you with information on inserting or removing dishes, arranging the food sequence accordingly, and automatically making the correct settings. Simple monitoring activities are no longer necessary.

The iCareSystem is an intelligent cleaning and descaling system in the iCombi Pro. It recognizes the current degree of dirt and calcification and suggests the ideal cleaning and chemical quantities from 9 cleaning programs. The ultra-fast intermediate cleaning cleans the iCombi Pro in just 12 minutes, and all cleaning programs can also run unsupervised overnight.

MAIN FEATURES

- Effective steam generator
- Core temperature probe with 6 measuring points
- High-resolution touchscreen
- Ergonomic door handle
- Adjustable door stopper
- Intelligent control of cooking paths with automatic adjustment
- Individual, intuitive programming by drag-and-drop of up to 1,200 cooking programmes

iCombi Pro 61, L20045
22-01-24 (14:21)

TECHNICAL DATA

iCombi Pro 61, L20045, 22-01-24 (14:21)

Model Number Specific	iCombi Pro 61
Voltage (V)	230
Phase	3
Frequency (Hz)	50/60
Loading (kW)	10,8
Max Amps in Phase (A)	27,1
Fuse (A)	32
IP Class	X5
Capacity, pans (pcs)	6
Width, net (mm)	850
Depth, net (mm)	842
Height, net (mm)	754
Weight, net (kg)	99
Weight, gross (kg)	110
Volume, net (m3)	0,54
Volume, gross (m3)	0,7
Connection Cable, length (m)	0
Plug type	None
Adapted for container sizes	GN
Automatic cleaning system	Yes
Certifications	CE
Chlorides (mg/l)	80
Cold water inlet temperature (°C)	max 30
Cold water inlet, diameter (")	3/4
Door Hanging	Right
Drain pipe, diameter (mm)	50
Hardness, min (dH°)	5
Installation, type	Floor model
Marine feet	No
Noise level <(dB)	56
Oven, type	Combi
Pan sizes	GN1/1
Pressure (Bar)	3
Temperature, max (°C)	300

Loipart AB (HQ), Sweden
Tel. +46 313 920 100, loipart@loipart.se

LMG Finland oy, Finland
+358 40 664 6680, lmg@lmg.fi



Loipart USA inc, USA
Tel. +1 954 530 5276, loipartusa@loipart.com

Loipart SEA Pte Ltd, Singapore
Tel. +65 674 99 100, contact@loipart.sg

Visit us at www.loipart.com

Touch control	Yes
USPH	Yes
Water pressure, max (Bar)	6
Water pressure, min (Bar)	1

Loipart AB (HQ), **Sweden**
Tel. +46 313 920 100, loipart@loipart.se

LMG Finland oy, **Finland**
+358 40 664 6680, lmg@lmg.fi



Loipart USA inc, **USA**
Tel. +1 954 530 5276, loipartusa@loipart.com

Loipart SEA Pte Ltd, **Singapore**
Tel. +65 674 99 100, contact@loipart.sg

Visit us at www.loipart.com

DIMENSIONS

Model: iCombi Pro 61 Rev.2

FRONT

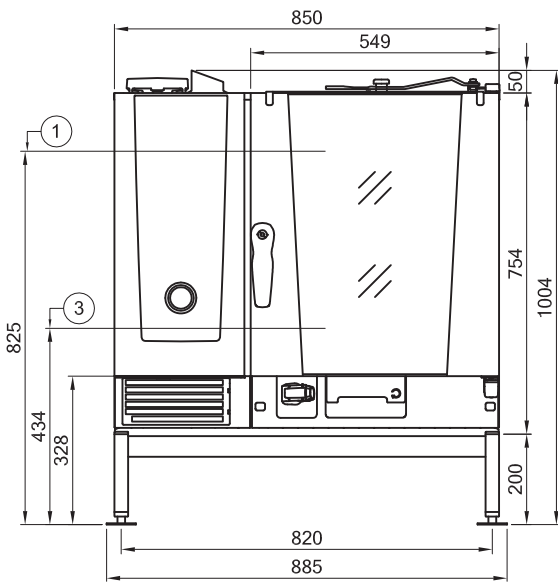

SIDE

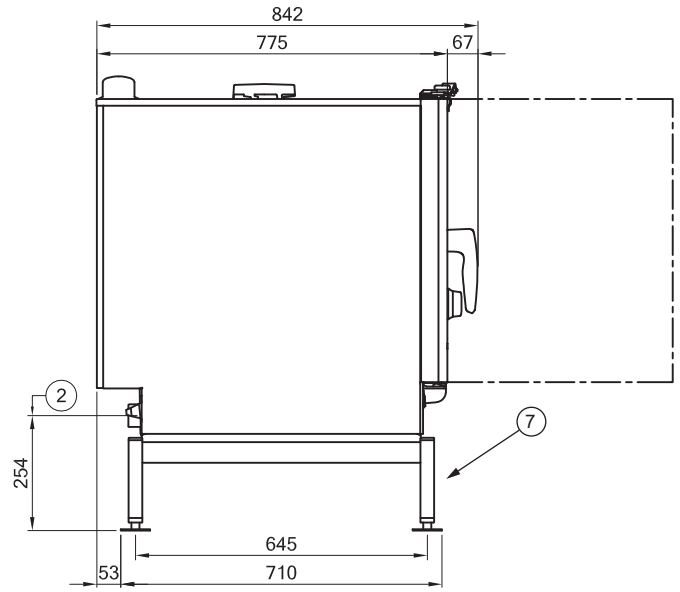

TOP

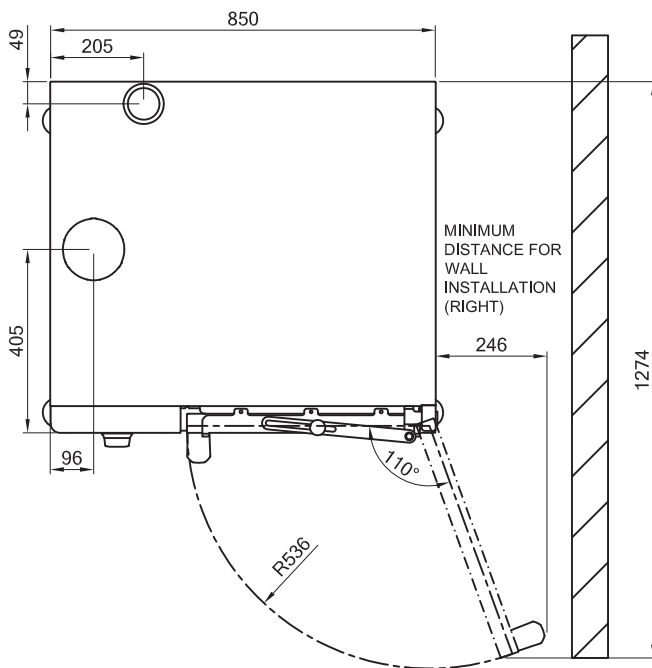

BACK

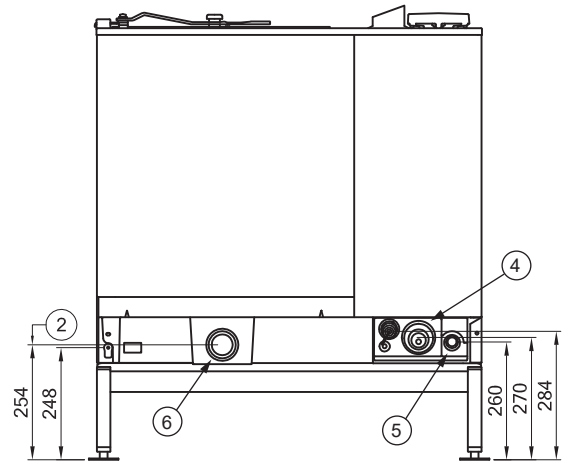

1. Height of top rail
2. Drain height
3. Unit access height
4. Power supply
5. Water connection
6. Drain
7. Low stand (optional accessory)

Minimum distance to the device

Minimum distance to all sides

Set up the device taking into account the minimum distances to the wall. The distances depend on the device size, as shown in the table below.

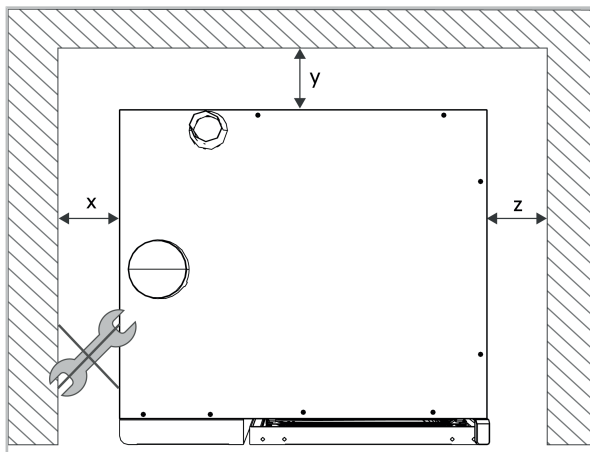

Device size	XS	6 half size	6 full size	10 half size	10 full size	20 half size	20 full size
x (mm)	10	50	50	50	50	500	500
x (inch)	1/2	2	2	2	2	20	20
y (mm)	10	0	0	0	0	0	0
y (inch)	1/2	0	0	0	0	0	0
z (mm)	10	50	50	50	50	50	50
z (inch)	1/2	2	2	2	2	2	2

Recommended distance to the left side of the device

To ensure that there is sufficient space on the left side of the device to carry out service work in the installation area, place the device on the left side at a recommended minimum distance from the wall.

If this distance to the left side of the device is not possible, place the device so that it can be pulled out of the niche for maintenance work.

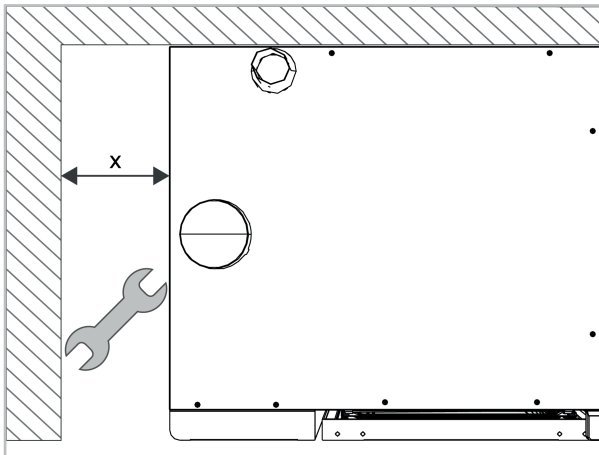

	Distance to the left side of the device
x (mm)	500
x (inch)	20

Recommended distance to the right side of the device

To open the device door at the first grid, place the device on the right with a recommended minimum distance to the wall. The distance depends on the device size, as shown in the table below.

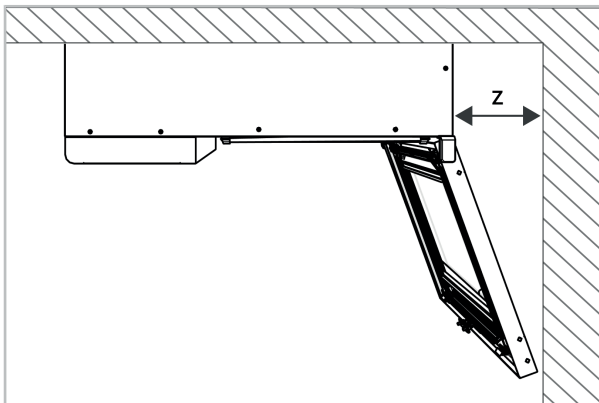

Device size	XS	6 half size	6 full size	10 half size	10 full size	20 half size	20 full size
z (mm)	279	246	316	246	316	268	338
z (inch)	11	10	12 1/2	10	12 1/2	11	13