



## COMBI OVEN ICOMBI CLASSIC 10 GN 1/1

**Model: iCombi Classic 101**

**Article no: L20076**

**Power supply: 440V 3Ph ~50/60Hz**

The iCombi Classic works at a consistently high level, thanks to the central measurement and regulatory system for a uniform, individual cooking cabinet climate; the powerful fresh steam generator for optimal steam saturation; the high-performance dehumidification; increased quantity of fan wheels and optimal cooking cabinet design. This combined means energy is transferred to the food with precision and, where appropriate, with a lot of power. The result: large load size with excellent uniform results across all the racks. With up to 10% less energy and water consumption. For the one objective: producing consistently high quality results with crisp crusts, attractive diamond grill patterns, crispy breaded products.

The iCombi Classic features an effective steam generator for optimal steam performance even at low temperatures below 100 °C. Individual programming of up to 100 single or multi-level cooking programmes with up to 12 increments. Integrated, maintenance-free grease separation system with no additional grease filter

Care system: Automatic cleaning and descaling of steam generator. 4 different cleaning programmes for unsupervised cleaning, even overnight.

### MAIN FEATURES

- Effective steam generator
- Colour display and soft keys
- Easy to use
- Effective cleaning
- Ergonomic door handle
- Adjustable door stopper

iCombi Classic 101, L20076  
22-01-24 (14:14)

## TECHNICAL DATA

iCombi Classic 101, L20076, 22-01-24 (14:14)

<b>Model Number Specific</b>	iCombi Classic 101
<b>Voltage (V)</b>	440
<b>Phase</b>	3
<b>Frequency (Hz)</b>	50/60
<b>Loading (kW)</b>	18,9
<b>Max Amps in Phase (A)</b>	24,8
<b>Fuse (A)</b>	32
<b>IP Class</b>	X5
<b>Capacity, pans (pcs)</b>	10
<b>Width, net (mm)</b>	850
<b>Depth, net (mm)</b>	842
<b>Height, net (mm)</b>	1014
<b>Weight, net (kg)</b>	121
<b>Weight, gross (kg)</b>	140
<b>Volume, net (m3)</b>	0,73
<b>Volume, gross (m3)</b>	0,94
<b>Connection Cable, length (m)</b>	0
<b>Plug type</b>	None
<b>Adapted for container sizes</b>	GN
<b>Automatic cleaning system</b>	Yes
<b>Certifications</b>	CE
<b>Chlorides (mg/l)</b>	80
<b>Cold water inlet temperature (°C)</b>	max 30
<b>Cold water inlet, diameter (")</b>	3/4
<b>Drain pipe, diameter (mm)</b>	50
<b>Hardness, min (dH°)</b>	5
<b>Installation, type</b>	Floor model
<b>Marine feet</b>	No
<b>Noise level &lt;(dB)</b>	56
<b>Oven, type</b>	Combi
<b>Pan sizes</b>	GN1/1
<b>Pressure (Bar)</b>	3
<b>Temperature, max (°C)</b>	300
<b>Touch control</b>	No

Loipart AB (HQ), Sweden  
Tel. +46 313 920 100, loipart@loipart.se

LMG Finland oy, Finland  
+358 40 664 6680, lmg@lmg.fi



Loipart USA inc, USA  
Tel. +1 954 530 5276, loipartusa@loipart.com

Loipart SEA Pte Ltd, Singapore  
Tel. +65 674 99 100, contact@loipart.sg

Visit us at [www.loipart.com](http://www.loipart.com)

<b>USPH</b>	Yes
<b>Water pressure, max (Bar)</b>	6
<b>Water pressure, min (Bar)</b>	1

---

Loipart AB (HQ), **Sweden**  
Tel. +46 313 920 100, loipart@loipart.se

LMG Finland oy, **Finland**  
+358 40 664 6680, lmg@lmg.fi



Loipart USA inc, **USA**  
Tel. +1 954 530 5276, loipartusa@loipart.com

Loipart SEA Pte Ltd, **Singapore**  
Tel. +65 674 99 100, contact@loipart.sg

Visit us at [www.loipart.com](http://www.loipart.com)

# DIMENSIONS

Model: iCombi Classic 101 Rev. 1

FRONT

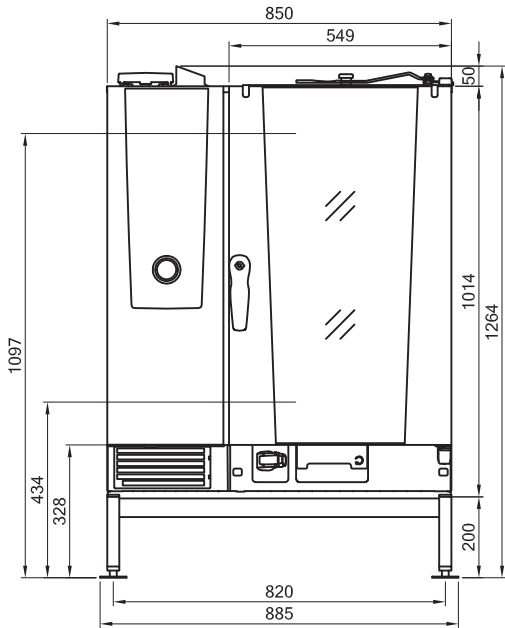

SIDE

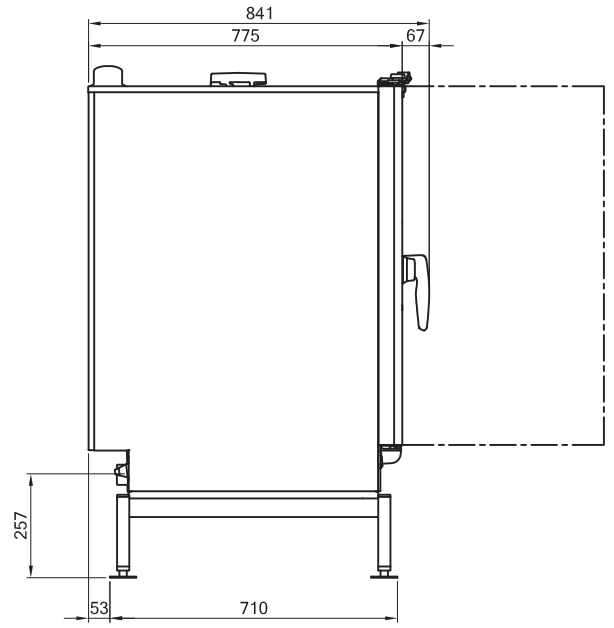

TOP

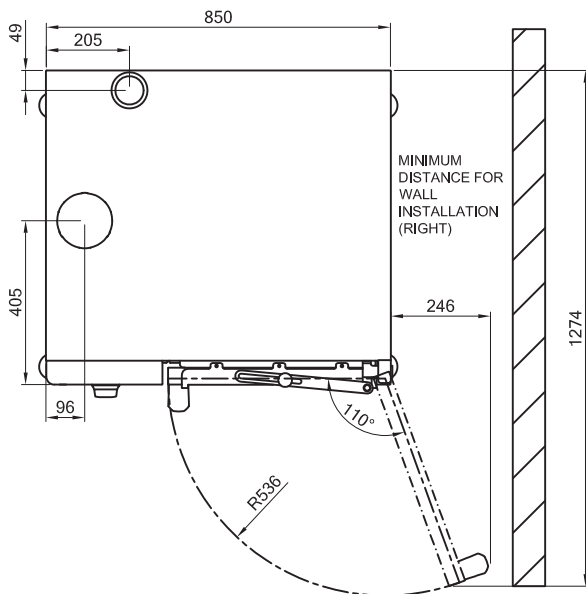

BACK

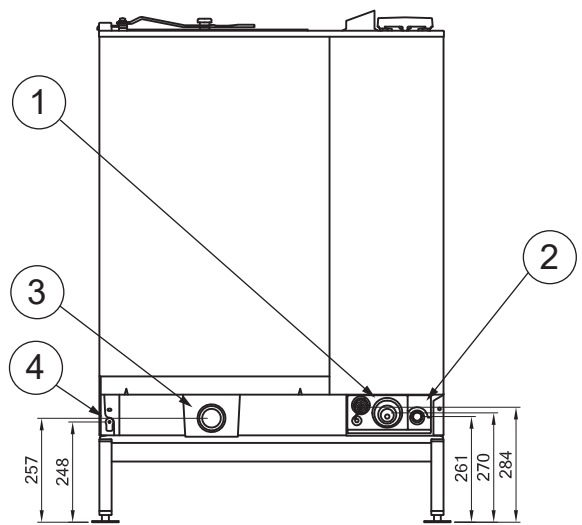

1. Electrical connection
2. Cold water connection
3. Drain
4. Equipotential bonding

Minimum distance to the device

Minimum distance to all sides

Set up the device taking into account the minimum distances to the wall. The distances depend on the device size, as shown in the table below.

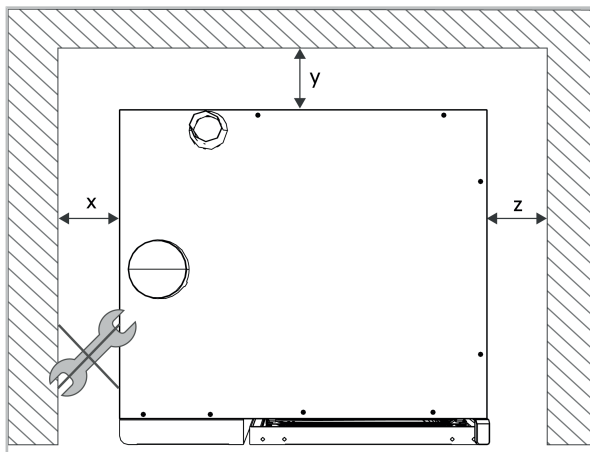

Device size	XS	6 half size	6 full size	10 half size	10 full size	20 half size	20 full size
x (mm)	10	50	50	50	50	500	500
x (inch)	1/2	2	2	2	2	20	20
y (mm)	10	0	0	0	0	0	0
y (inch)	1/2	0	0	0	0	0	0
z (mm)	10	50	50	50	50	50	50
z (inch)	1/2	2	2	2	2	2	2

Recommended distance to the left side of the device

To ensure that there is sufficient space on the left side of the device to carry out service work in the installation area, place the device on the left side at a recommended minimum distance from the wall.

# DIMENSIONS

Model: iCombi Pro 101 Rev. 2

FRONT

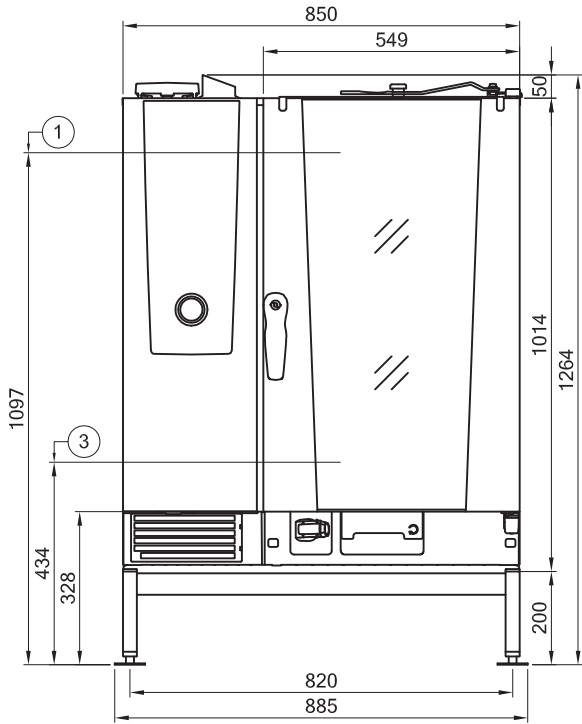

SIDE

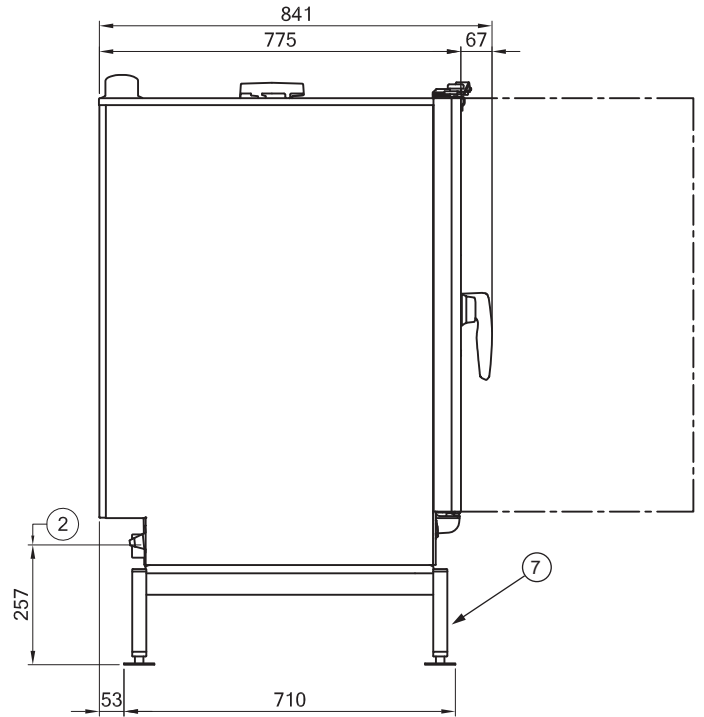

TOP

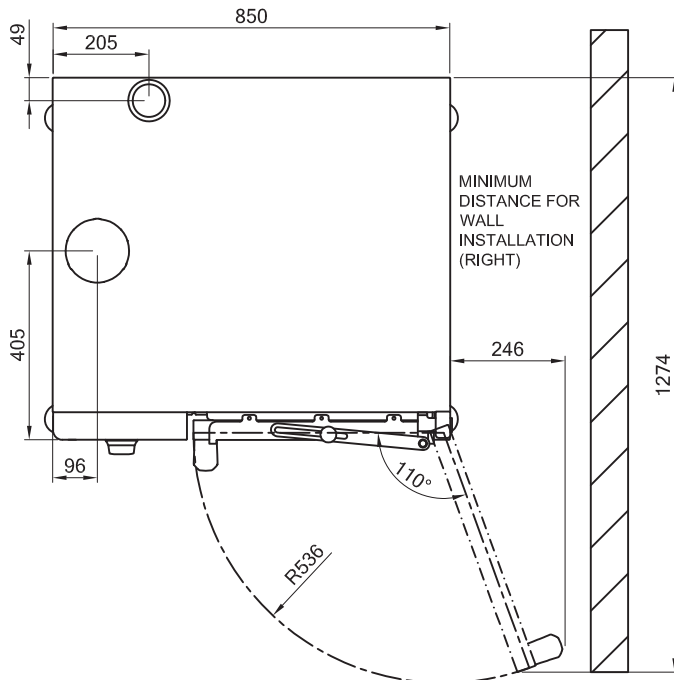

BACK

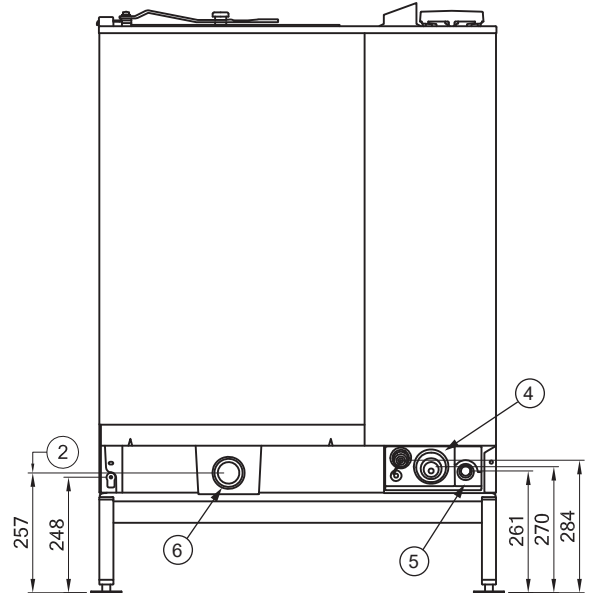

1. Height of top rail
2. Drain height
3. Unit access height
4. Power supply
5. Water connection
6. Drain
7. Low stand (optional accessory)

If this distance to the left side of the device is not possible, place the device so that it can be pulled out of the niche for maintenance work.

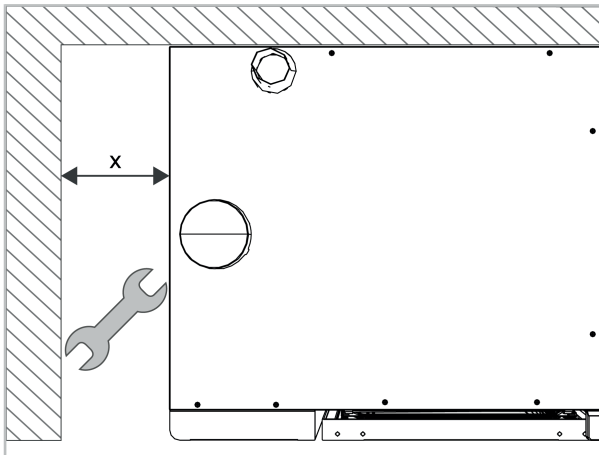

	Distance to the left side of the device
x (mm)	500
x (inch)	20

**Recommended distance to the right side of the device**

To open the device door at the first grid, place the device on the right with a recommended minimum distance to the wall. The distance depends on the device size, as shown in the table below.

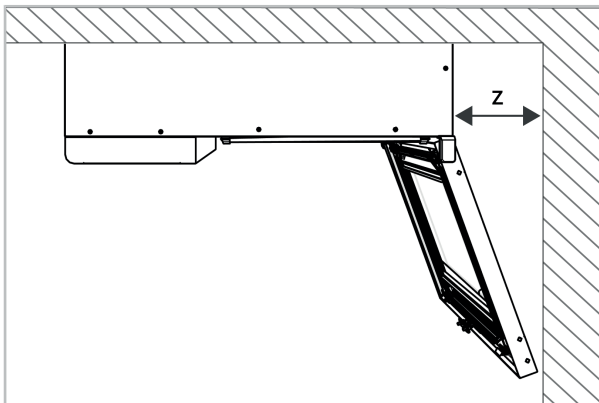

Device size	XS	6 half size	6 full size	10 half size	10 full size	20 half size	20 full size
z (mm)	279	246	316	246	316	268	338
z (inch)	11	10	12 1/2	10	12 1/2	11	13